

LILY BEARING

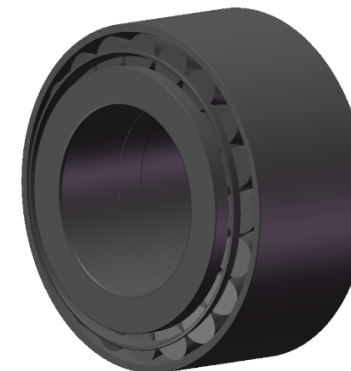

- d1: 596 mm Dia Of Shaft Abutment
- a: 269 mm Distance Between Pressure Point
- R1: 1.5 mm Chamfer Dimension Of Outer Ring
- R2: 6.4 mm Chamfer Dimension Of Inner Ring

**LILY**<sup>®</sup>

SHANGHAI LILY BEARING LIMITED

Email: [lilybearing@lily-bearing.com](mailto:lilybearing@lily-bearing.com)

Part  
Number

BT2B-332605-A-HA1 Double row tapered roller bearing